

Devil

by Jun Maekawa

Devil (I) - Diagrams: Hugo Pereira ©2002

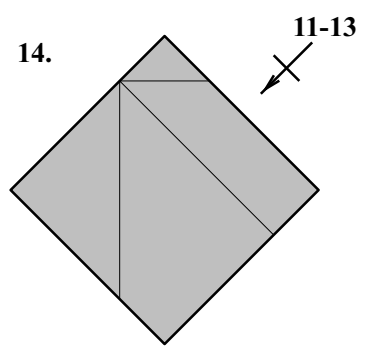
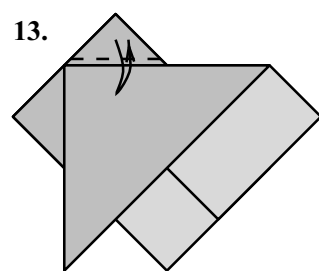
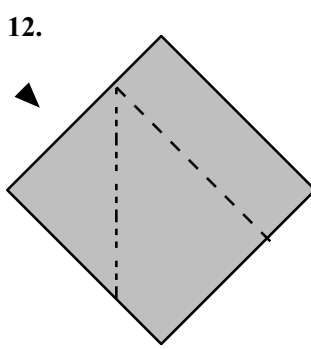
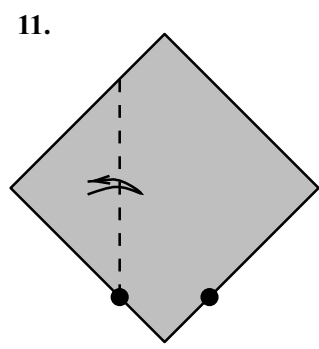
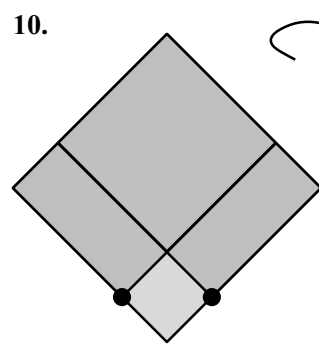
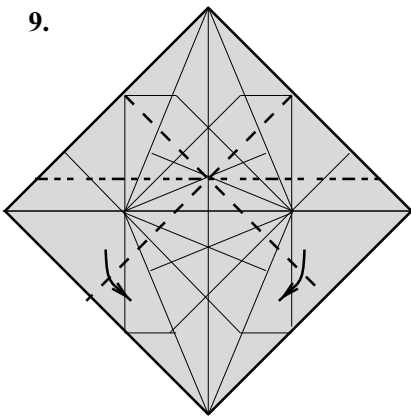
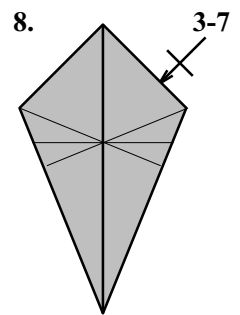
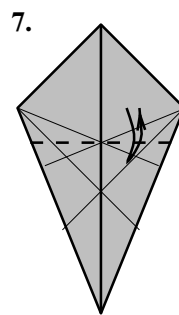
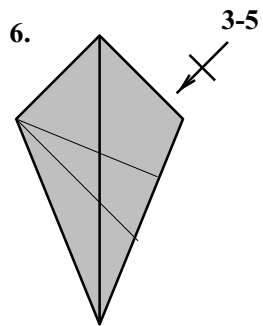
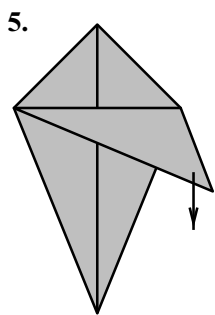
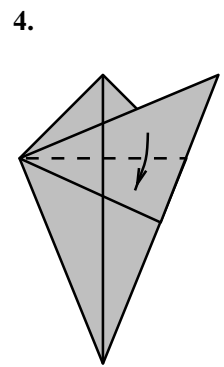
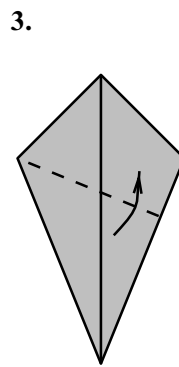
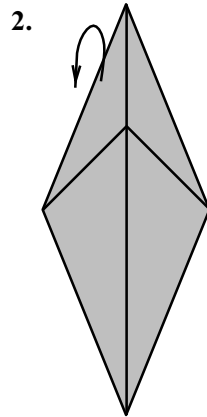
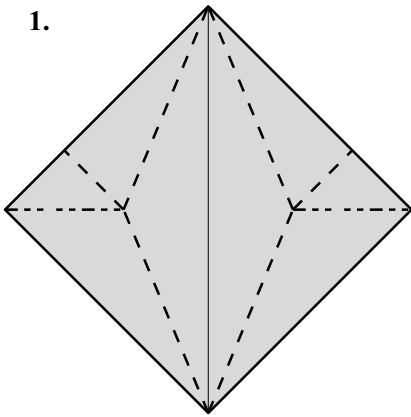

Devil (II) - Diagrams: Hugo Pereira ©2002

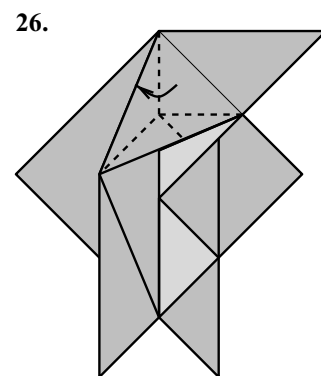
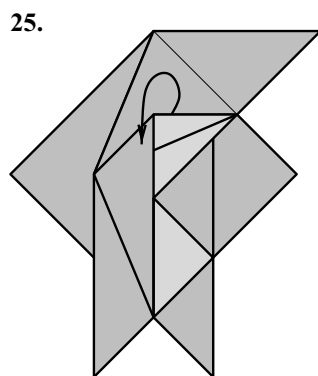
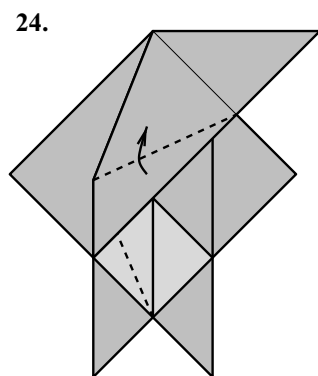
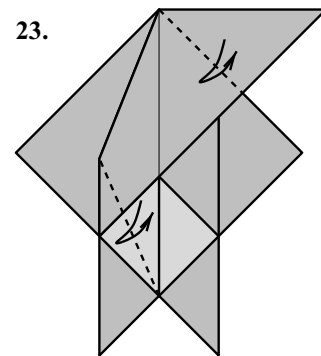
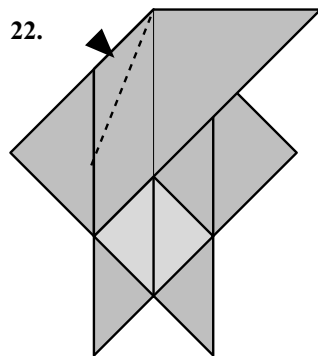
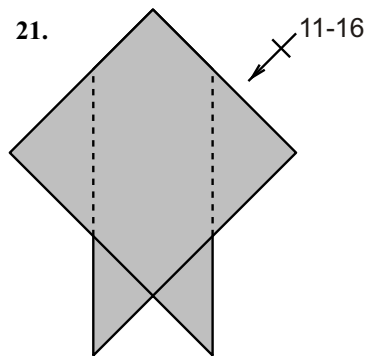
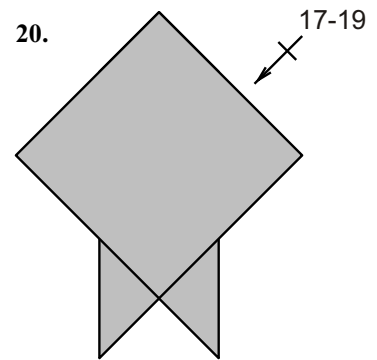
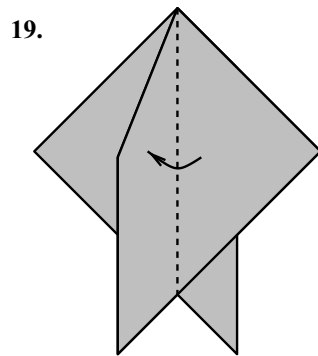
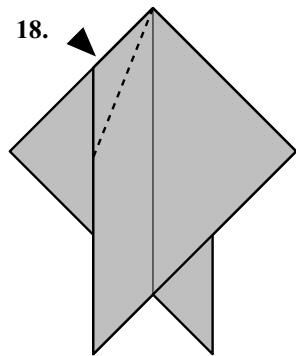
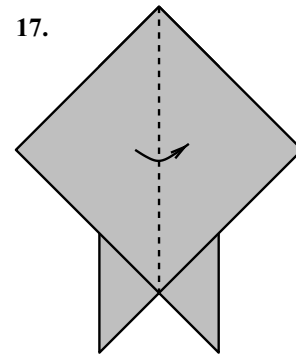
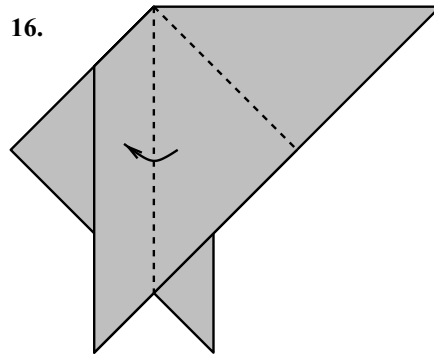
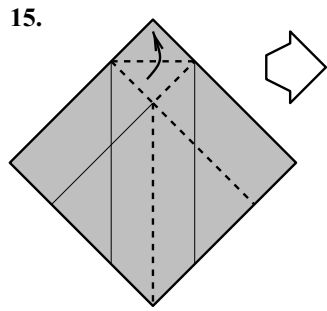

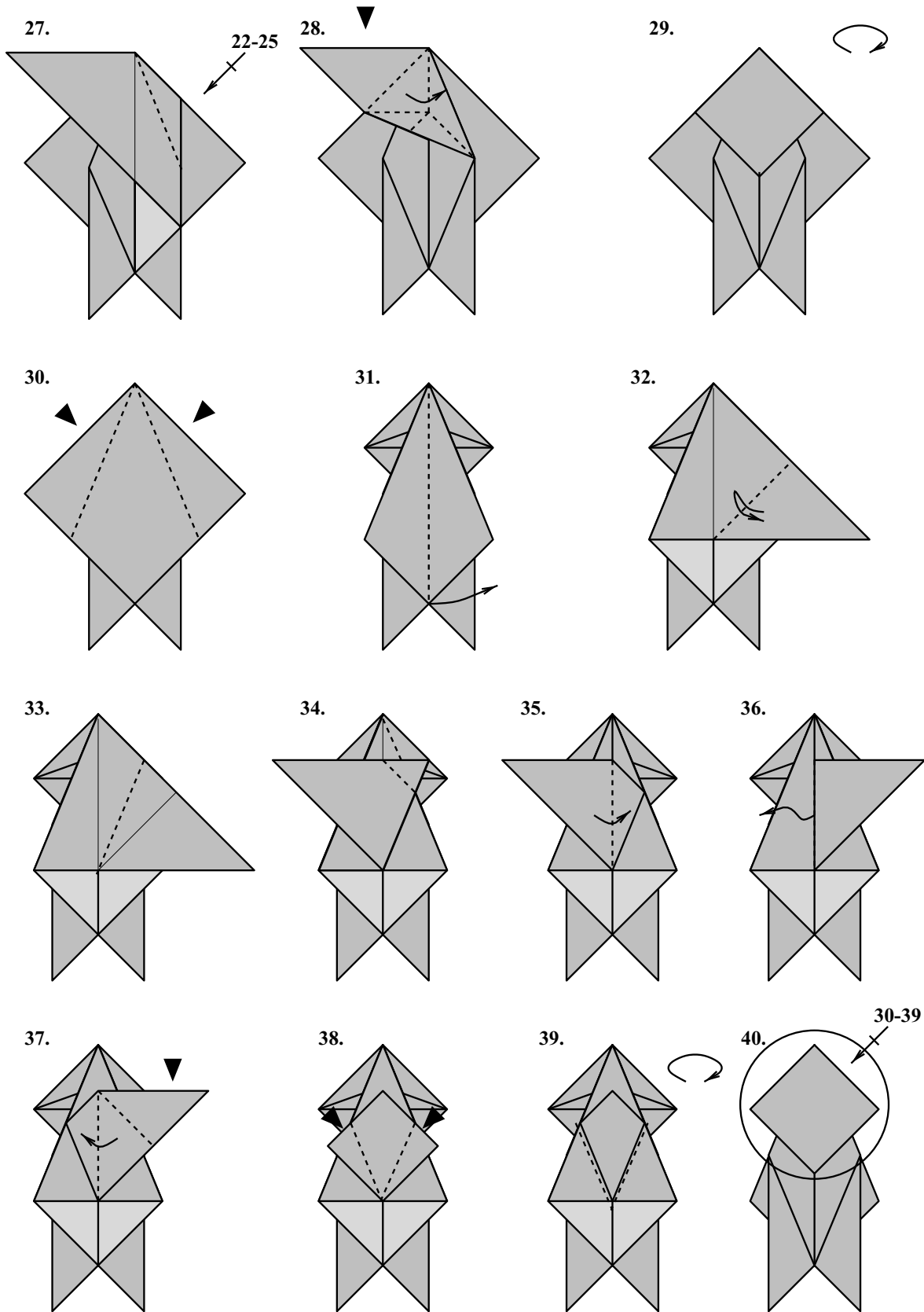

Devil (IV) - Diagrams: Hugo Pereira ©2002

41.

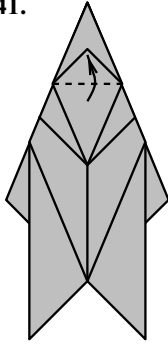

42.

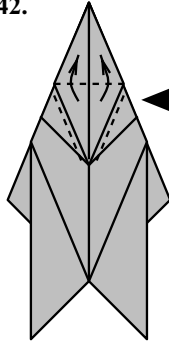

43.

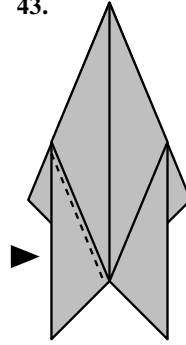

44.

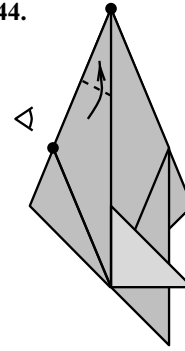

45.

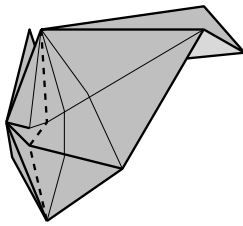

46.

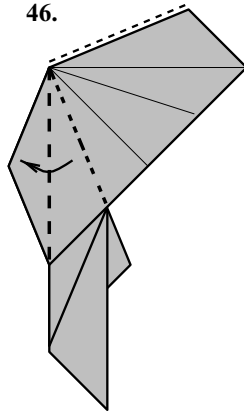

47.

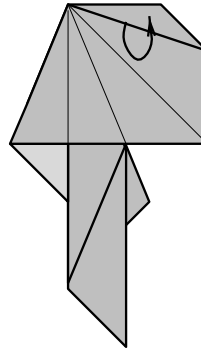

48.

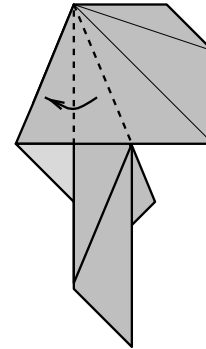

49.

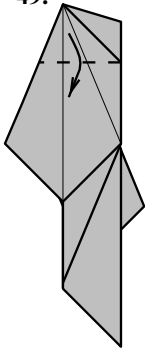

50.

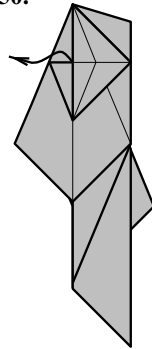

51.

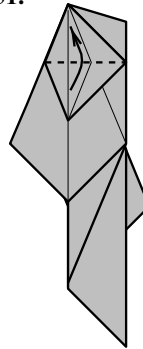

52.

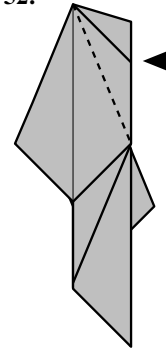

53.

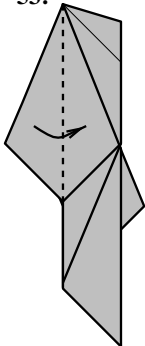

54.

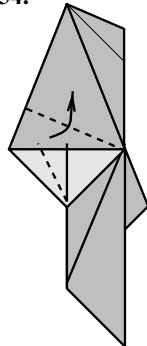

55.

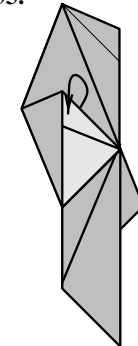

56.

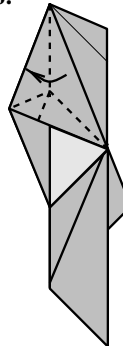

57.

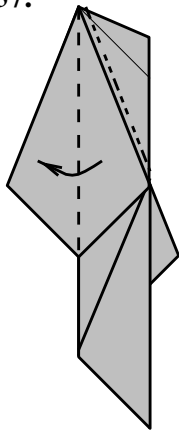

58.

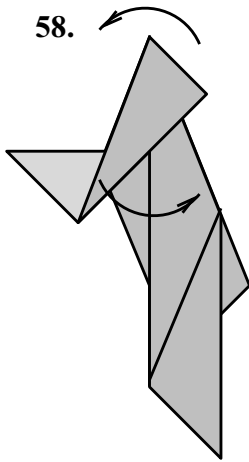

59.

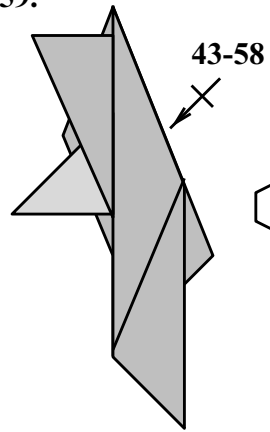

60.

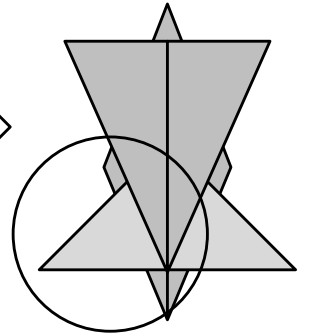

61.

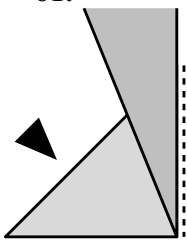

62.

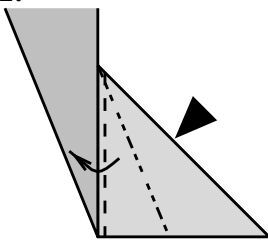

63.

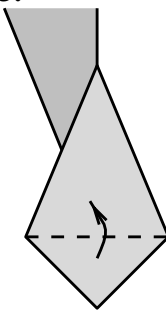

64.

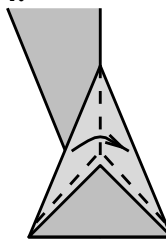

65.

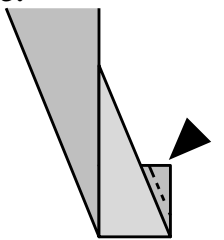

66.

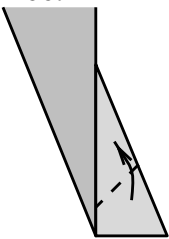

67.

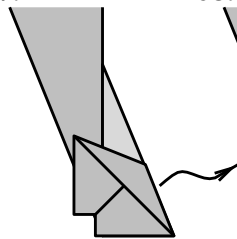

68.

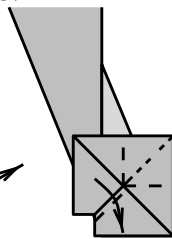

69.

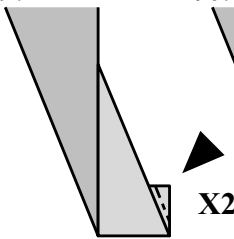

70.

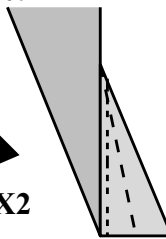

71.



72.

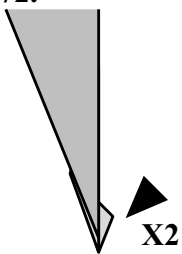

73.

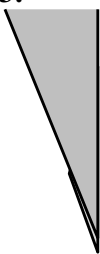

74.

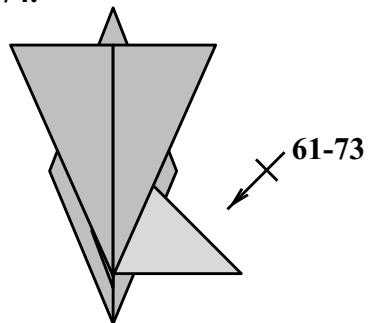

75.

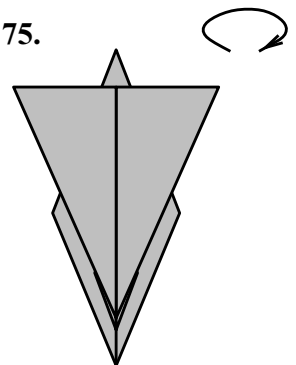

76.

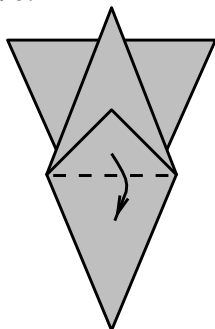

77.

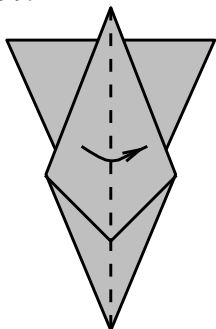

78.

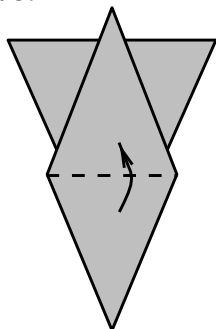

79.

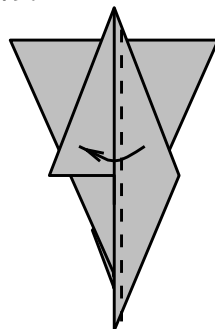

80.

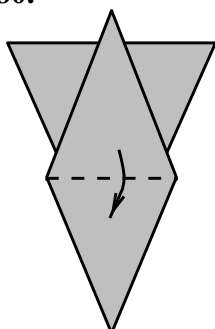

81.

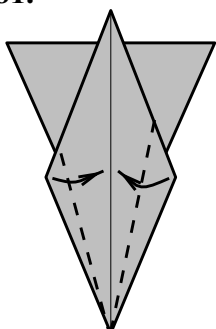

82.

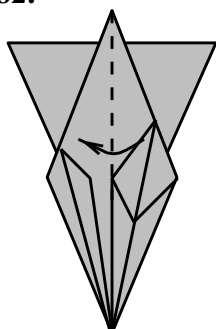

83.

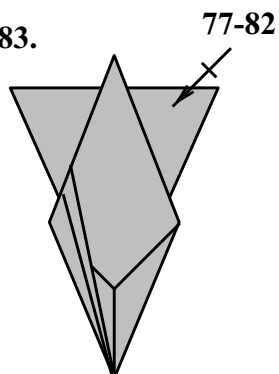

84.

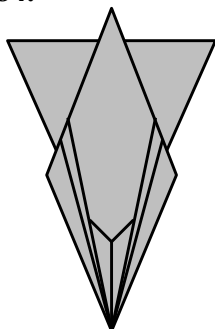

85.

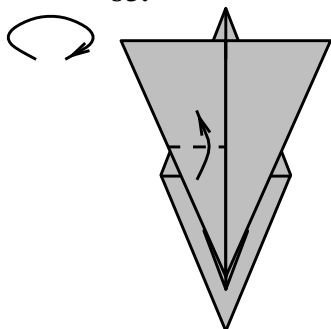

86.

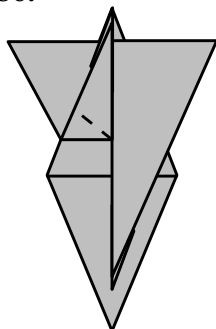

87.

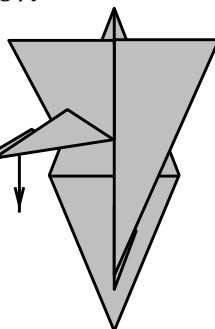

88.

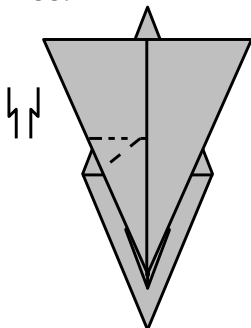

89.

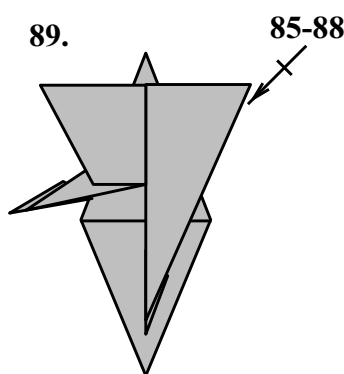

90.

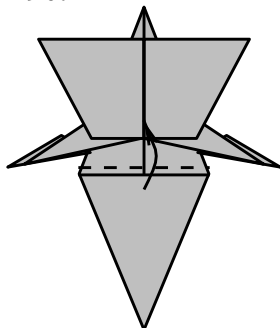

91.

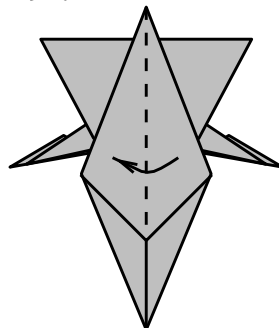

92.

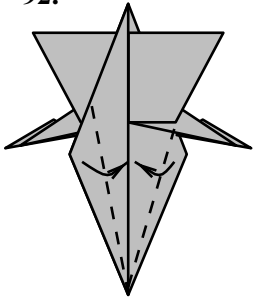

93.

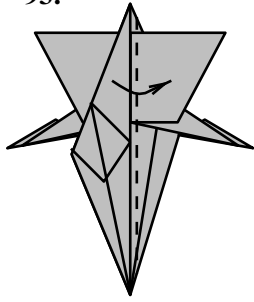

94.

91-93

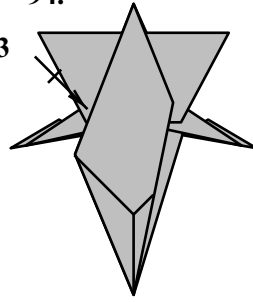

95.

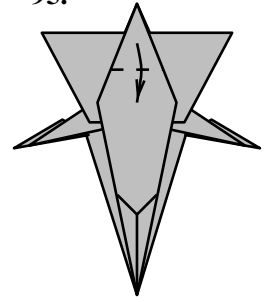

96.

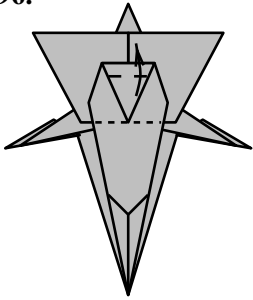

97.

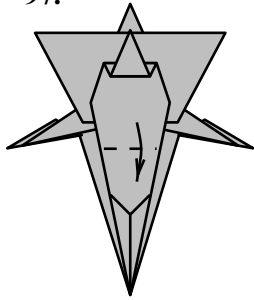

98.

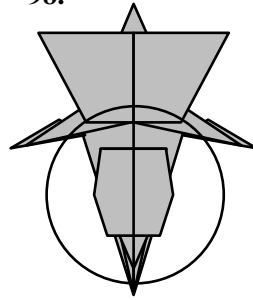

99.

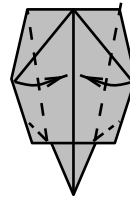

100.

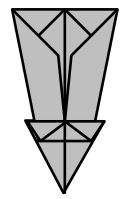

101.

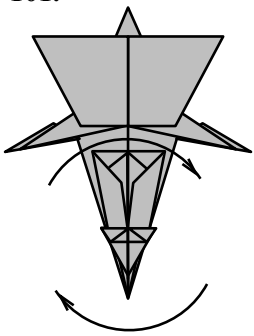

102.

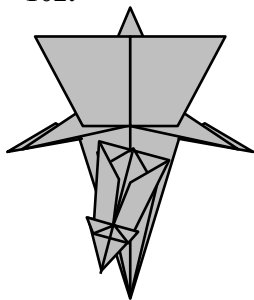

103.

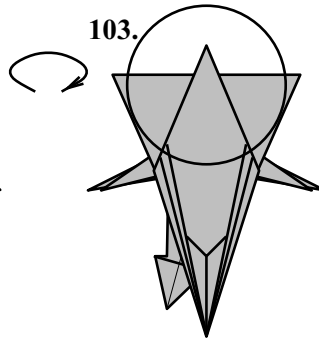

104.



105.

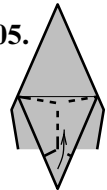

106.

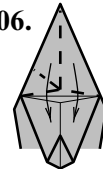

107.

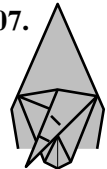

108.

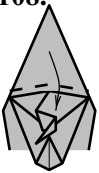

109.

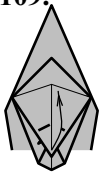

110.



111.



112.



113.

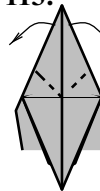

114.

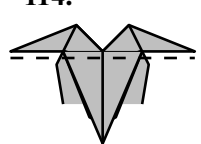

115.

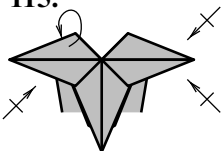

116.

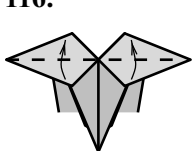

117.

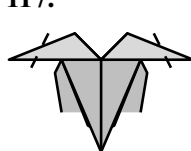

118.

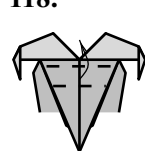

119.

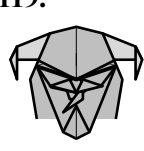

120.
X8

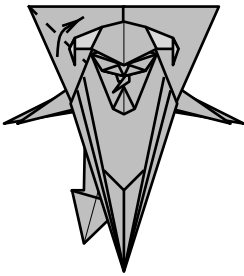

121.

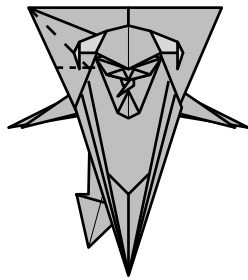

122.

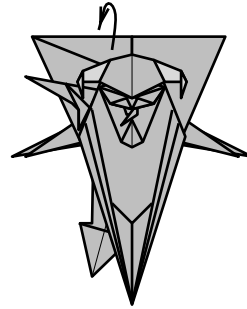

123.

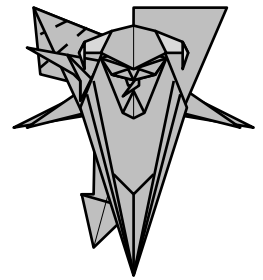

124.

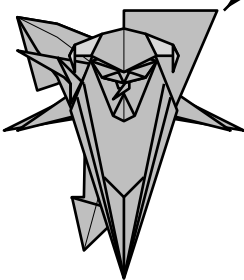

120-123

125.

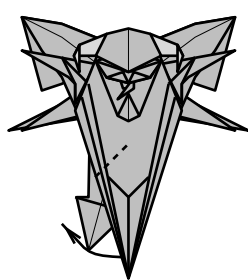

126.

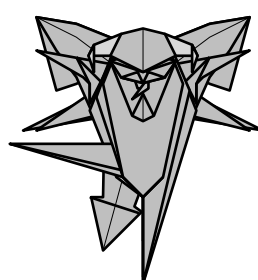

127.

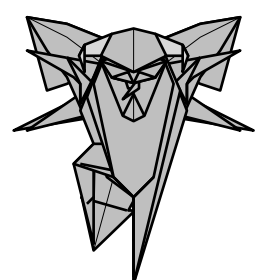

128.

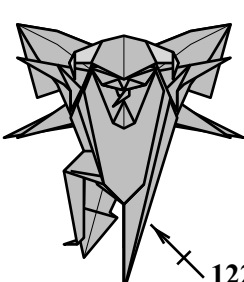

129.

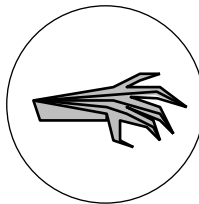
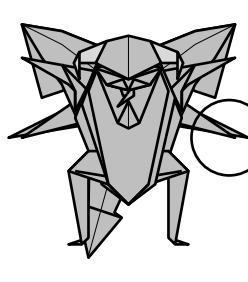

130.



122-124

Comments

1. Start with a square, white face up. Rabbit ear on both sides (fish base).
2. Swing down the flap behind.
3. Valley fold up at perpendicular.
4. Valley fold down at angle bisector.
5. Unfold back to step 3.
6. Repeat steps 3 to 5 on the other side.
7. Precrease through intersection of creases.
8. Repeat steps 3 to 7 behind. Unfold back to step 1.
9. The crease pattern should look so. Fold a preliminary base using the shifted indicated creases.
10. Note where the corners are. Turn over.
11. Fold and unfold through the corner on the back side.
12. Swivel fold along indicated creases.
13. Precrease along the front flap. Unfold back to step 12.
14. Repeat steps 11 to 13 on the other side.
15. Collapse the front flap using existing creases.
16. Squash fold to the left.
17. Valley fold one flap to the right.
18. Open sink at angle bisector.
19. Valley fold to the left.
20. Repeat steps 17 to 19 on the right side.
21. Repeat steps 11 to 16 on the front flap.
22. Open sink at angle bisector.
23. Precrease at angle bisector.
24. Swivel up.
25. Wrap around one layer.

26. Valley fold to the left adding a reverse fold.
27. Repeat steps 22 to 25 on the right.
28. Squash fold to the right, adding a reverse fold (like in step 26).
29. Turn over.
30. Inside reverse fold at angle bisector on both sides.
31. Raise the bottom corner to the right, adding a mountain fold.
32. Precrease at angle bisector.
33. Valley fold to the left, at angle bisector.
34. Inside reverse fold.
35. Valley fold to the right.
36. Pull out one layer (this is like undoing an open sink).
37. Squash fold to the left.
38. inside reverse fold on both sides.
39. Precrease where indicated; turn over.
40. Repeat steps 30 to 39 on the indicated square.
41. Valley fold one flap up.
42. Valley fold up one flap on each side, adding a reverse fold.
43. Inside reverse fold on the left side.
44. Difficult: valley fold up so that the indicated points meet. The model will not lie flat.
45. Side view of previous step: rearrange the creases inside the model (add mountain folds and rearrange the other creases inside the model to flatten it.
46. Like so. The next few steps (46 to 52) are needed to form the (second pair) of horns. They are difficult. You also can simply collapse the front flap to the left, with alternate valley and mountain folds along existing creases and go direct to step 53, thus skipping the horns. Otherwise, Swivel to the left using existing creases.
47. Wrap around one (this is like undoing a sink).
48. Swivel to the left using existing creases.
49. Difficult: valley fold down where indicated. You will have to carefully release some paper trapped inside the model.

50. Difficult: pull out one layer.
51. Valley fold up.
52. Open sink along existing crease.
53. Valley fold one flap to the right.
54. Swivel up.
55. Wrap around a single layer.
56. Valley fold to the left adding a reverse fold.
57. Swivel to the left.
58. Rotate the assembly adding valley folds on the inner layers (see next step for positioning).
59. Repeat steps 43 to 58 on the right side.
60. The next few steps (6 to 72) focus on the small indicated white flap, to form the left hand.
61. Flip the white flap to the right (undoing the reverse fold made at step 44).
62. Squash fold at angle bisector.
63. Valley fold up the lower triangle.
64. Valley fold to the right adding a reverse fold along the dark triangle.
65. Inside reverse fold along the front flap.
66. Valley fold up as far as you can (that is, along the reverse fold made at the previous step).
67. Unwrap some paper
68. Collapse back to step 66, adding a reverse fold along indicated creases.
69. Inside reverse fold (two small white flaps) on the right.
70. Crimp at angle bisector.
71. Inside reverse fold (two small dark flaps) on the left.
72. Inside reverse fold again, on the right.
73. The hand is completed: there are 5 layers at the bottom: one per finger.
74. Full view. Repeat steps 61 to 73 on the other side to form the right hand;

75. Turn over.

76. I like the next few steps a lot. The idea is to put the front flap behind, to form the tail. Valley fold the front flap down.

77. Valley fold one flap to the right.

78. Valley fold one flap up.

79. Valley fold one flap to the left.

80. Valley fold one flap down.

81. Valley fold on both sides towards the center. Note that the fold on the left is not at angle bisector.

82. Valley fold one flap to the left.

83. Repeat steps 77 to 82 on the right side.

84. Turn over.

85. Valley fold up the arm assembly as far as you can.

86. Valley fold down (see next step for positioning).

87. Unfold back to step 85.

88. Crimp along existing creases. Make sure that the same number of flaps are on each side of the crimp.

89. Repeat steps 85 to 88 on the right side.

90. Valley fold one flap up.

91. Valley fold the front flap to the left.

92. Valley fold on both sides towards the center. Note that the right crease is not at angle bisector.

93. Valley fold one flap to the right.

94. Repeat steps 91 to 93 on the other side.

95. Valley fold down the tip of the tail (see next step for positioning).

96. Valley fold up the tip of the tail (see next step for positioning).

97. Valley fold down the front flap.

98. The next two steps focuses on the tail.

99. Narrow the tail on both sides adding reverse folds at the tip, to form an arrow shape.

100. Like so.
101. Full view. Rotate the tail clockwise, using valley fold.
102. Turn over.
103. The next few steps (102 to 116) focuses on the top of the model, to form the head. The folds are slightly 3D.
104. Valley fold one flap down.
105. Valley fold up and pinch to form lower jaw.
106. Rabbit ear one flap down.
107. Add valley and mountain fold to form the tongue.
108. Valley fold one flap down.
109. Valley fold up.
110. Valley fold the corners to form the upper jaw and the nose.
111. Valley fold one (smaller) flap down, to form the eyes and the forehead.
112. Valley fold one flap down.
113. Inside reverse fold on both sides.
114. Valley fold down.
115. Wrap around two layers on both sides, top on bottom, (colour reversal for the first pair of horns)
116. Valley fold up on both sides.
117. Outside reverse fold on both sides to complete the (first pair) of horns.
118. Valley fold the front flap up to complete the forehead.
119. The head is completed. Shape it 3D.
120. Full view. Valley fold up 8 (!) layers.
121. Rabbit ear the front flap to form the left horn.
122. Flip one layer behind.
123. Add valley folds to shape the wing 3D.
124. Repeat steps 1290 to 120 on the right side.
125. Inside reverse fold the left leg, as far as you can, inside the model.

126. Inside reverse fold down.

127. Inside reverse fold to form the left feet.

128. Repeat steps 122-124 on the right side.

129. Close up of the right and. Shape the fingers as indicated.

130. The Devil is completed.